

QTG55

ASSEMBLY INSTRUCTIONS & DIMESNION

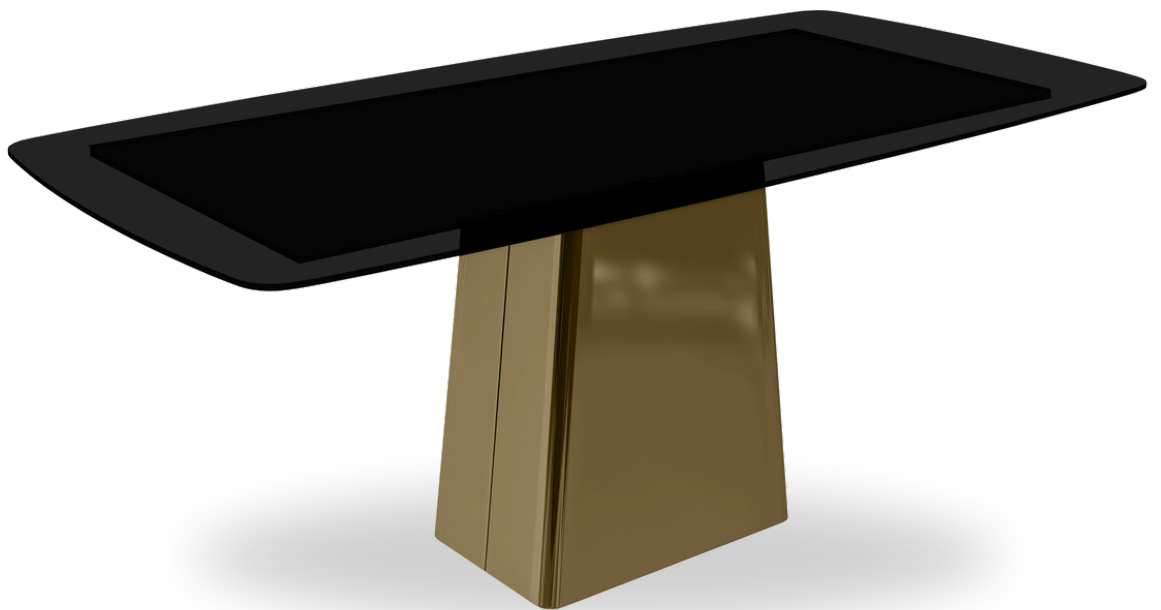

LeisureMod

Phone: (201) 429-7715

Email: Info@LeisureMod.com



QTG55

ASSEMBLY INSTRUCTIONS & DIMESNION



Read through the instructions carefully before you begin.

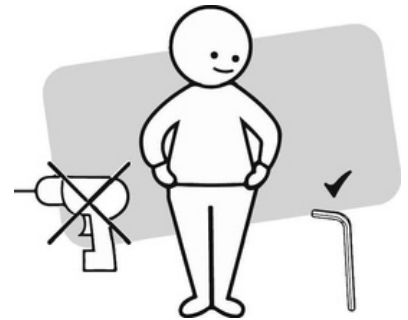

Make sure you have all the required tools. Never use power tools unless instructed.

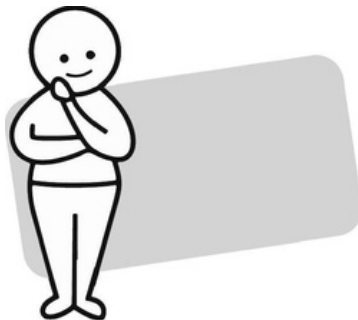

Identify and lay out all of the components before assembling.

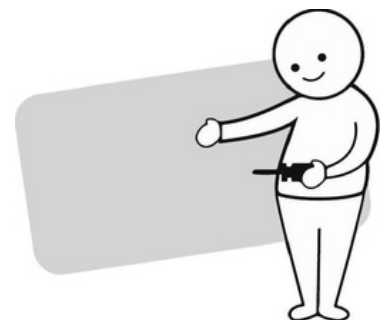

Unless instructed, do not fully tighten screws until the item is fully assembly.



Retain these instructions for future reference.



Do not discard any of the packaging until you have checked that you have all the parts and the pack of fixings.

LeisureMod

Phone: (201) 429-7715

Email: Info@LeisureMod.com



QTG55

ASSEMBLY INSTRUCTIONS & DIMENSION



WARNING! TO REDUCE THE RISK OF SERIOUS INJURY, READ THE FOLLOWING SAFETY INSTRUCTIONS BEFORE ASSEMBLING AND USING THE PRODUCT.

Please read and understand this entire manual before attempting to assemble, operate, or install the product.

Any assembly or maintenance of the product must be carried out by adults only.

Some parts may contain sharp edges. Wear protective gloves if necessary.

To prevent damage, place all parts on a level surface during assembly. Add a layer of protective surface if needed.

Due to the nature of steel, surface oxidation (rusting) will occur if this protective coating is scratched. This is a natural process. To minimize this condition, it is recommended that care be taken when assembling and handling the product in order to prevent the paint from being scratched.

TOOLS REQUIRED



2 person

NOTE:

To avoid damage, ensure screws are hand tightened.

DO NOT USE POWER TOOLS TO ASSEMBLE YOUR UNIT.

NOTE:

Philips head screw driver is required in the assembly process. However, manufacturer does not provide this item. Quantities shown are for one chair.

LeisureMod

Phone: (201) 429-7715

Email: Info@LeisureMod.com



QTG55

ASSEMBLY INSTRUCTIONS & DIMENSION

ASSEMBLY INSTRUCTIONS





ASSEMBLY TIPS:

1. Remove hardware from box and sort by size.
2. Please check to see that all hardware and parts are present prior to start of assembly.
3. Please follow attached instructions in the same sequence as numbered to assure fast & easy assembly.

WARNING!

1. Don't attempt to repair or modify parts that are broken or defective. Please contact the seller immediately.
2. This product is for home use only and not intended for commercial establishments.

PARTS CHECKLIST

A		8	E		4
B		8	F		
C		1	G		
D					

LeisureMod

Phone: (201) 429-7715

Email: Info@LeisureMod.com



QTG55

ASSEMBLY INSTRUCTIONS & DIMENSION

STEP 1

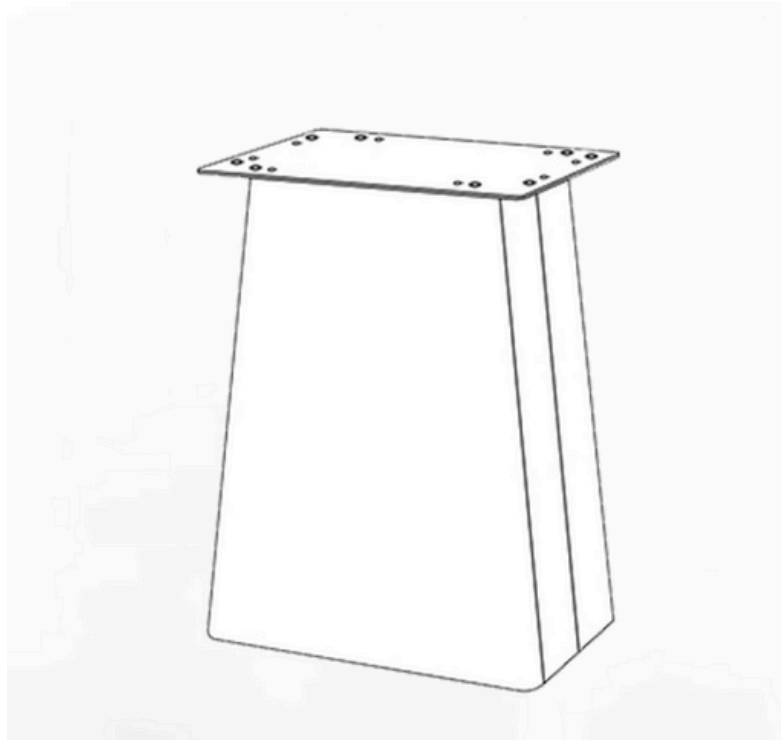

STEP 2

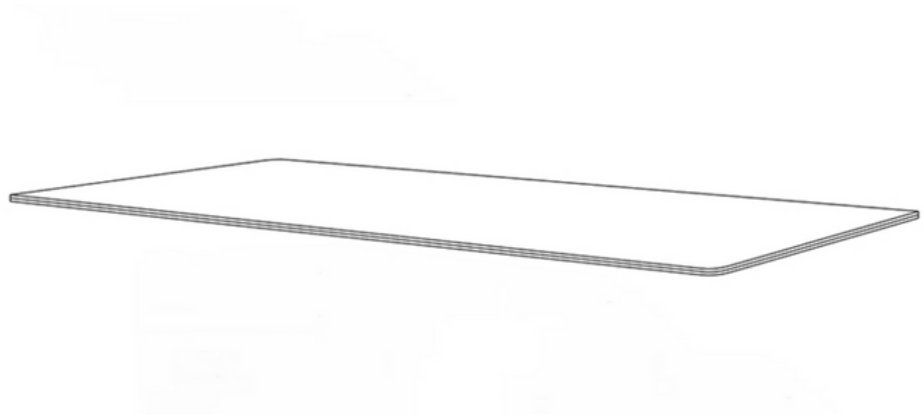

LeisureMod

Phone: (201) 429-7715

Email: Info@LeisureMod.com



Its Ready !!!

QTG55

ASSEMBLY INSTRUCTIONS & DIMENSION

STEP 3

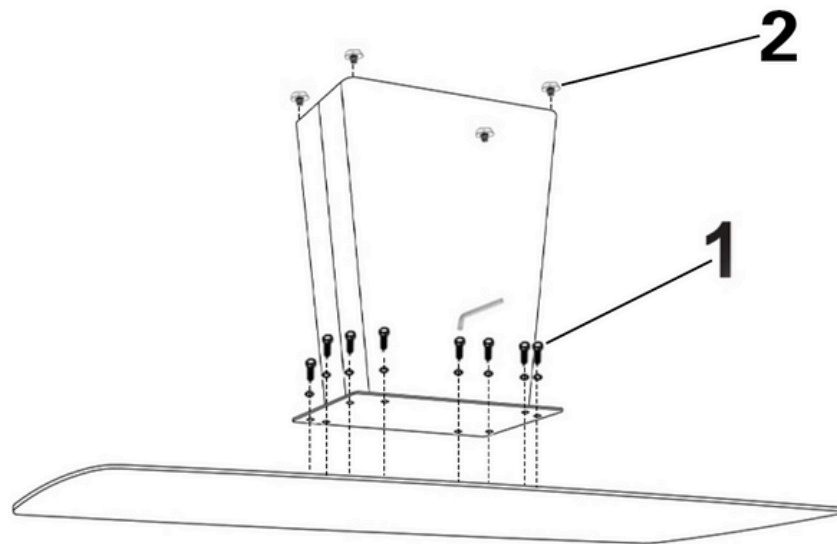

LeisureMod

Phone: (201) 429-7715

Email: Info@LeisureMod.com



QTG55

ASSEMBLY INSTRUCTIONS & DIMENSION

LEISUREMOD
YOUR OWN CLASSIC™

Overall Height - Top to Bottom	29.9 in.
Overall Width - Side to Side	55 in.
Overall Depth - Front to Back	31.50 in.

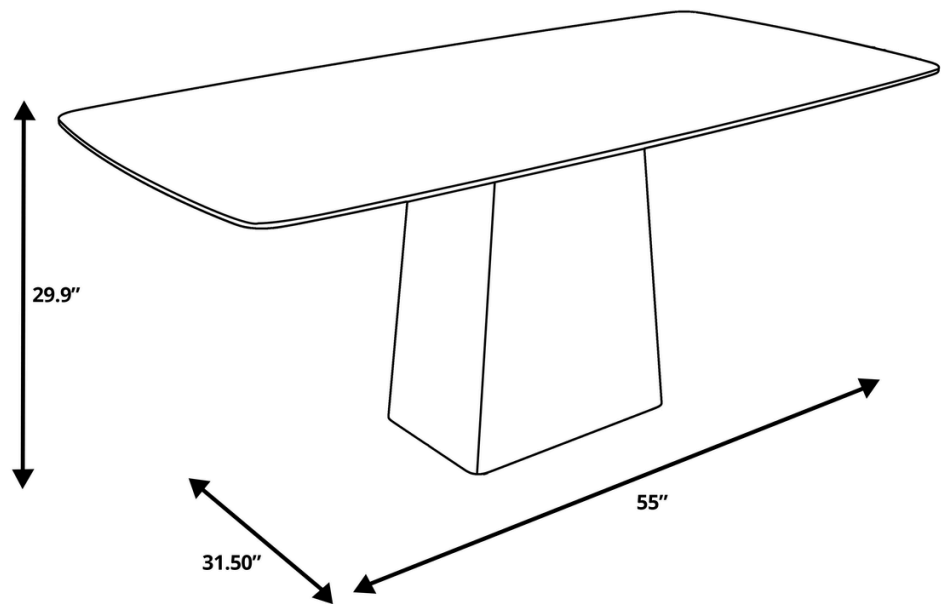

LeisureMod

Phone: (201) 429-7715

Email: Info@LeisureMod.com

